

**TO-92 Plastic-Encapsulate Transistors**

**3DD13002B** TRANSISTOR (NPN)

**FEATURE**

- Power Switching Applications

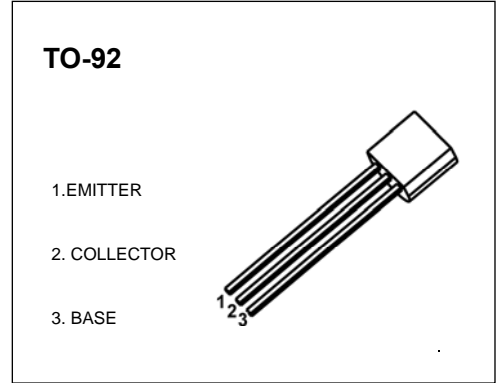

**MARKING**

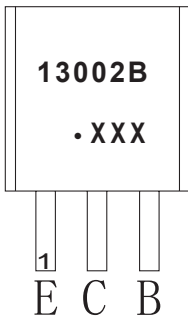

13002B=Device code  
Solid dot=Green molding compound device,  
if none,the normal device  
XXX=Code

**Equivalent Circuit**

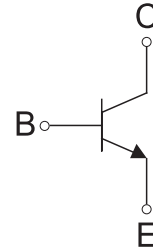

**ORDERING INFORMATION**

Part Number	Package	Packing Method	Pack Quantity
3DD13002B	TO-92	Bulk	1000pcs/Bag
3DD13002B-TA	TO-92	Tape	2000pcs/Box

**MAXIMUM RATINGS (T<sub>a</sub>=25°C unless otherwise noted)**

Symbol	Parameter	Value	Unit
V <sub>CBO</sub>	Collector-Base Voltage	600	V
V <sub>CEO</sub>	Collector-Emitter Voltage	400	V
V <sub>EBO</sub>	Emitter-Base Voltage	6	V
I <sub>C</sub>	Collector Current -Continuous	0.8	A
P <sub>C</sub>	Collector Power Dissipation	0.9	W
T <sub>J</sub> , T <sub>stg</sub>	Operation Junction and Storage Temperature Range	-55 ~ 150	°C

## ELECTRICAL CHARACTERISTICS

$T_a=25^\circ\text{C}$  unless otherwise specified

Parameter	Symbol	Test conditions	Min	Typ	Max	Unit
Collector-base breakdown voltage	$V_{(BR)CBO}$	$I_C=100\mu\text{A}, I_E=0$	600			V
Collector-emitter breakdown voltage	$V_{(BR)CEO}$	$I_C=1\text{mA}, I_B=0$	400			V
Emitter-base breakdown voltage	$V_{(BR)EBO}$	$I_E=100\mu\text{A}, I_C=0$	6			V
Collector cut-off current	$I_{CBO}$	$V_{CB}=600\text{V}, I_E=0$			100	$\mu\text{A}$
	$I_{CEO}$	$V_{CE}=400\text{V}, I_B=0$			100	$\mu\text{A}$
Emitter cut-off current	$I_{EBO}$	$V_{EB}=6\text{V}, I_C=0$			100	$\mu\text{A}$
Dc current gain	$h_{FE1}$	$V_{CE}=10\text{V}, I_C=200\text{mA}$	9		40	
	$h_{FE2}$	$V_{CE}=10\text{V}, I_C=0.25\text{mA}$	5			
Collector-emitter saturation voltage	$V_{CE(sat)}$	$I_C=200\text{mA}, I_B=40\text{mA}$			0.5	V
Base-emitter saturation voltage	$V_{BE(sat)}$	$I_C=200\text{mA}, I_B=40\text{mA}$			1.1	V
Transition frequency	$f_T$	$V_{CE}=10\text{V}, I_C=100\text{mA}$ $f=1\text{MHz}$	5			MHz
Fall time	$t_f$	$I_C=1\text{A}, I_{B1}=-I_{B2}=0.2\text{A}$			0.5	$\mu\text{s}$
Storage time	$t_s$	$V_{CC}=100\text{V}$			2.5	$\mu\text{s}$

### CLASSIFICATION OF $h_{FE1}$

Range	9-15	15-20	20-25	25-30	30-35	35-40

# Typical Characteristics

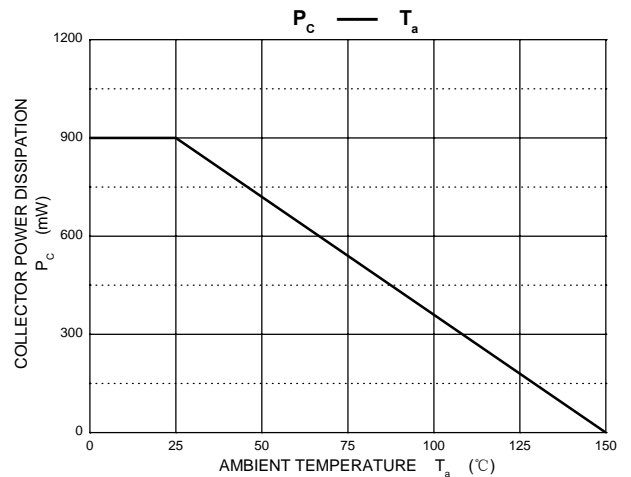
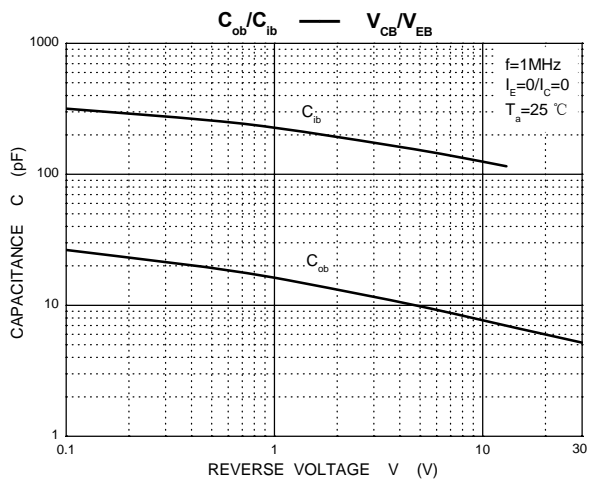
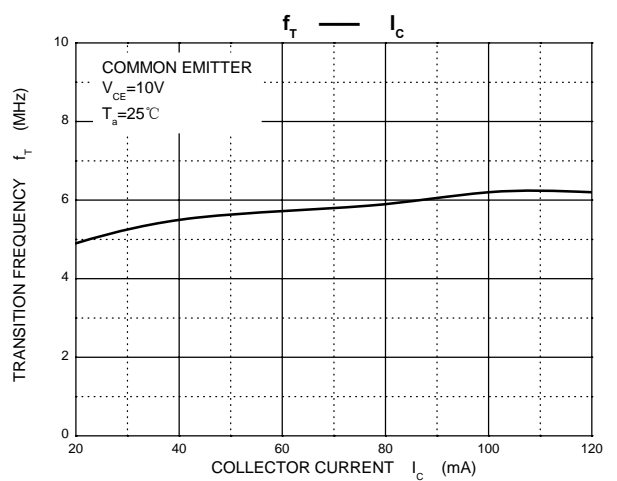
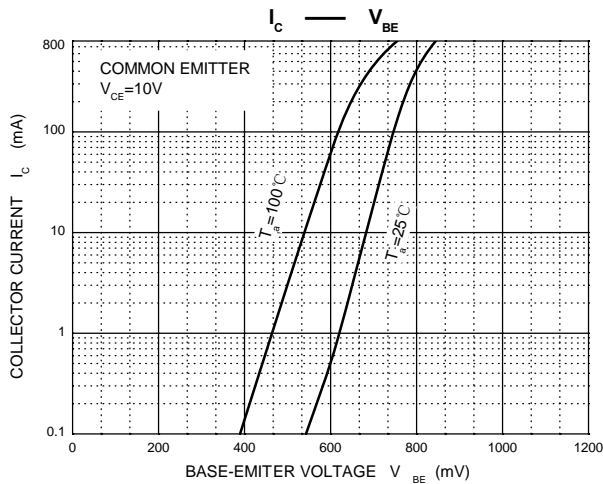
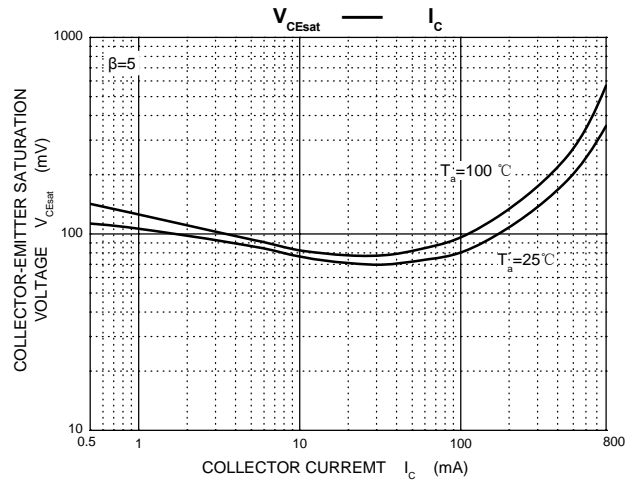
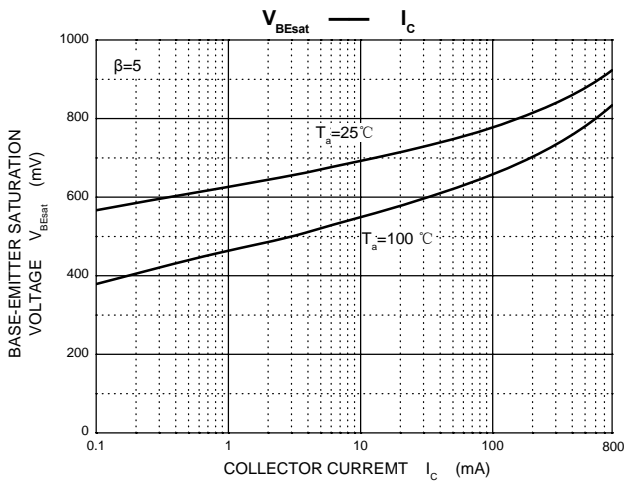
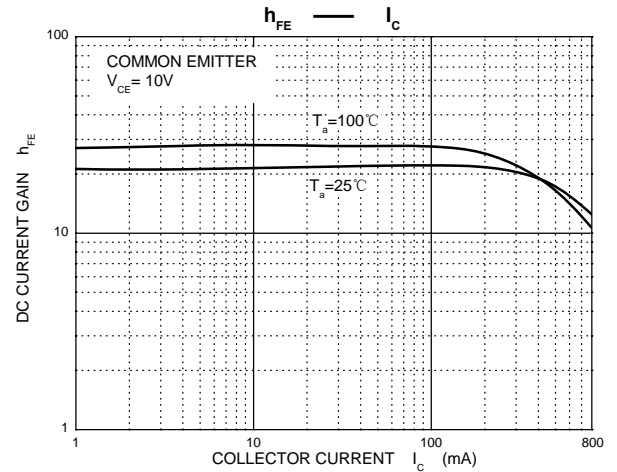
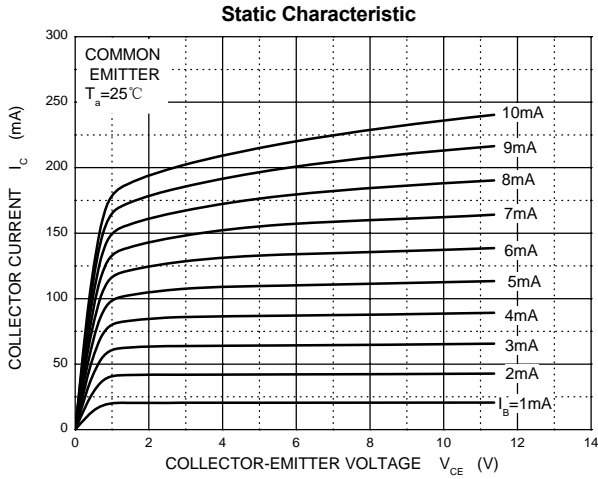

## TO-92 Package Outline Dimensions

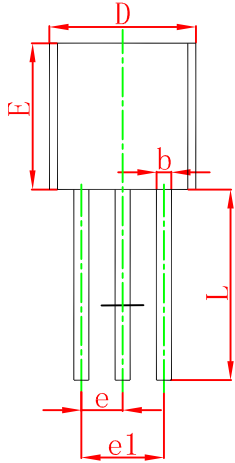

Symbol	Dimensions In Millimeters		Dimensions In Inches	
	Min	Max	Min	Max
A	3.300	3.700	0.130	0.146
A1	1.100	1.400	0.043	0.055
b	0.380	0.550	0.015	0.022
c	0.360	0.510	0.014	0.020
D	4.400	4.700	0.173	0.185
D1	3.430		0.135	
E	4.300	4.700	0.169	0.185
e	1.270 TYP		0.050 TYP	
e1	2.440	2.640	0.096	0.104
L	14.100	14.500	0.555	0.571
Φ		1.600		0.063
h	0.000	0.380	0.000	0.015

## TO-92 Suggested Pad Layout

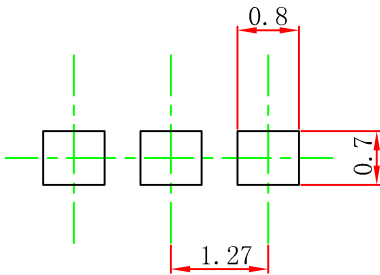

### Note:

1. Controlling dimension: in millimeters.
2. General tolerance:  $\pm 0.05\text{mm}$ .
3. The pad layout is for reference purposes only.

### NOTICE

JSCJ reserves the right to make modifications, enhancements, improvements, corrections or other changes without further notice to any product herein. JSCJ does not assume any liability arising out of the application or use of any product described herein.

TO-92 PACKAGE TAPEING DIMENSION

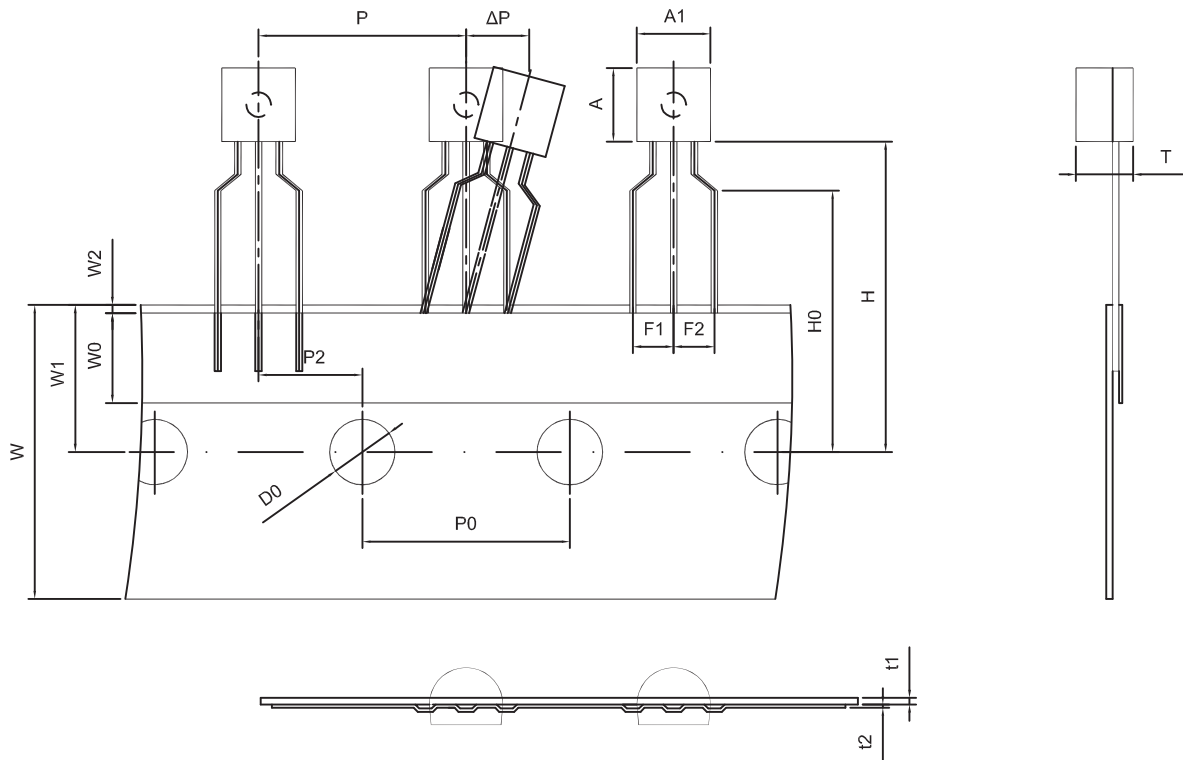

Dimiensions are in millimeter								
A1	A	T	P	P0	P2	F1	F2	W
4.5	4.5	3.5	12.7	12.7	6.35	2.5	2.5	18.0
W0	W1	W2	H	H0	D0	t1	t2	ΔP
6.0	9.0	1.0 MAX.	19.0	16.0	4.0	0.4	0.2	0

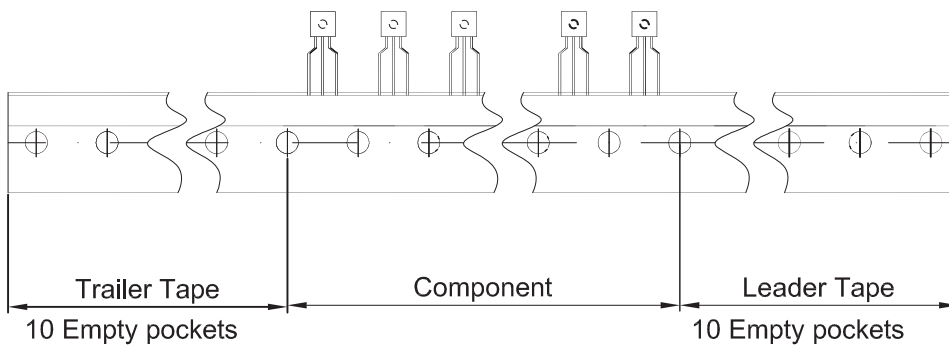

Package	Box	Box Size(mm)	Carton	Carton Size(mm)
TO-92	2000 pcs	333×162×43	20,000 pcs	350×340×250